

Product specification

Accupack with charging controller LDR2112

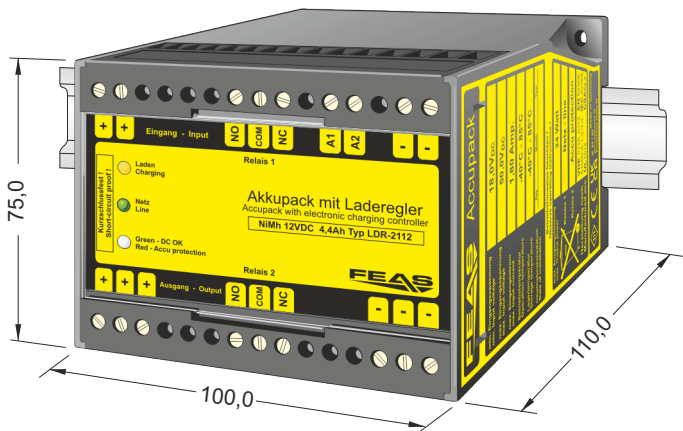

- Input range: 18.0 - 50.0 V_{DC}
- Extreme temperature accumulators -40°C .. +85°C
- Buffered time: 2,0h (typ. 12V/1.8A)
- Operating status shown by LED: Line-In, charging-level, buffer-mode
- Remote monitoring: Line-In failed, charging-level, sleeping mode
- Selective protection of critical consumer
- Safeguard against total discharge
- Overload and open circuit protected, short circuit proof
- Suitable for the tropics, vibration proof
exposy resin casted
- Extra low safety potential
PELV (EN 60204), SELV (EN 62368)
- Easy mounting on a rail according to DIN 46277 or on wall
- Safety acc. to VDE, EN, UL, CSA

Application

The accupack LDR is connected between the unregulated DC power supply and the powered system. If the line power fails, the system is supplied from the NiMH-accumulator, which is integrated in the LDR. The duration of the supply depends on the quantity of the load current of the system.

During mains operation the internal DC-DC converter supplies the DC-consumer system and simultaneously charges the accumulator with an optimal loading technique. Thereby the output voltage follows the accu voltage. Preferably, the LDR is powered with the FEAS power supply PSLC283.

Functional principle

At the first operation of the LDR, the accumulator is charged. This is shown by the yellow LED "charging". The LED "Line" will light green, when a line voltage is detected. The lower LED will light red, when the batteries are nearly discharged and before the LDR's protection against low discharge will switch off the system. The DC-consumer system is then unsupplied.

To enable remote monitoring of the accupack, it has 2 build-in relays. After a power failure and the return of the line voltage afterwards the maximal output current is available immediately. Simultaneously the accu is charging. When fully charged, the accu is switched to trickle charging to compensate the loss of self-discharging.

Design

The LDR is delivered in a flame resistant plastics housing for mounting on a rail according to DIN 46277 or for wall mounting with screws.

Wiring diagram with buffered an unbuffered load

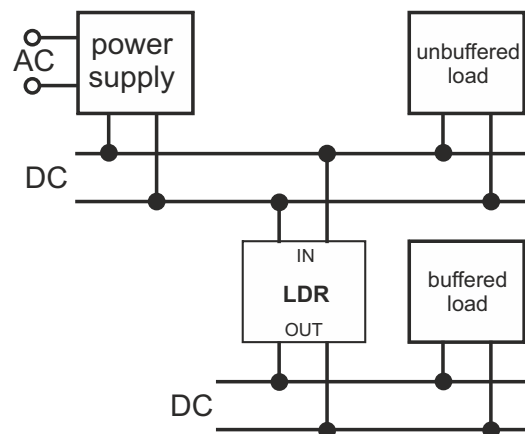

Discharge current diagramm at 20°C

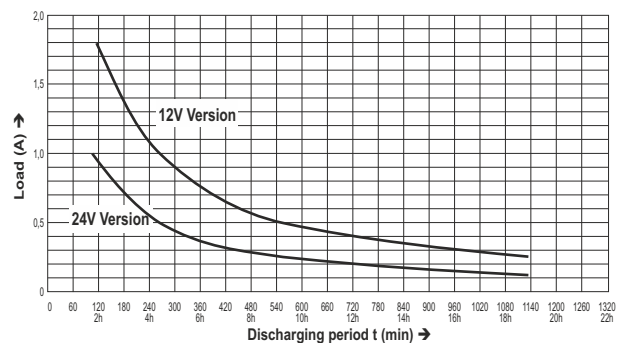

Please read the data sheets and the operating instructions for further information!



Postfach 1521
D - 22905 Ahrensburg

Phone: +49 4102 42082
Telefax: +49 4102 40930

E-Mail : sales@feas.com
Internet: www.feas.com